

KOLI C-15

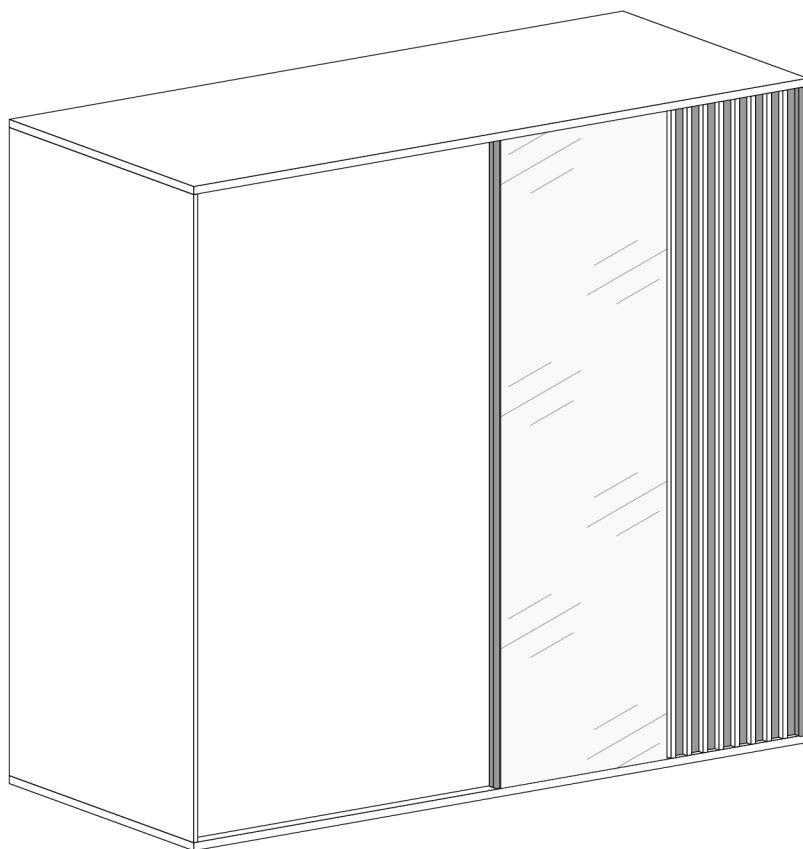

1	2096	600	16	1
2	2096	600	16	1
3	1991	602	32	1
4	1991	602	32	1
5	2096	450	16	1
6	960	450	16	1
7	960	450	16	1
8	472	450	16	1
9	472	450	16	1
10	1297	450	16	1
11	960	450	16	4
12	472	450	16	4
13	2118	990	2,5	2
14	2060	1000	16	1
15	2060	1000	32	1
16	100	80	16	1

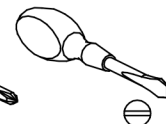
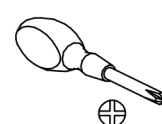
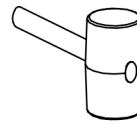
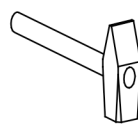
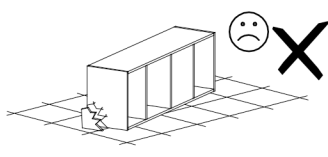
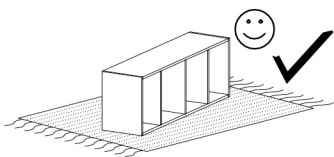
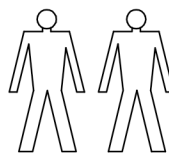
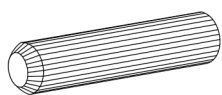

A - 24

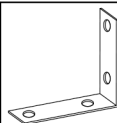

Y1 - 1

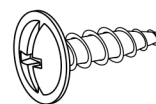

Y2 - 2
3,5x16



X1 - 36

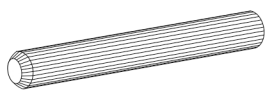

A1 - 4

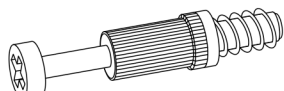

B - 28

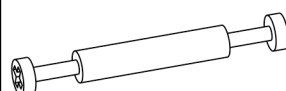

B1 - 4

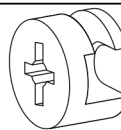

C - 36



D - 6

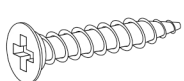

E - 12
3,5x25

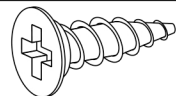

F - 64
3,5x16

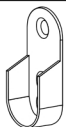

G - 2



H - 1



I - 4

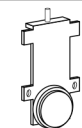

J - 4

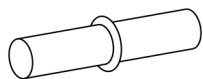

K - 32

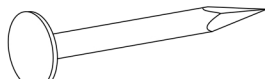

L - 120

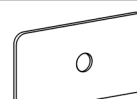

M - 20



N - 2

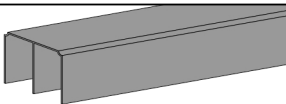

O - 1

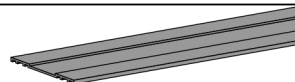

P - 1

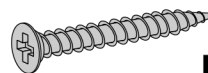

R - 2
3,9x30

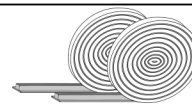

S - 3x2,06

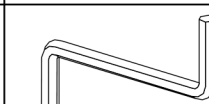

Z - 1

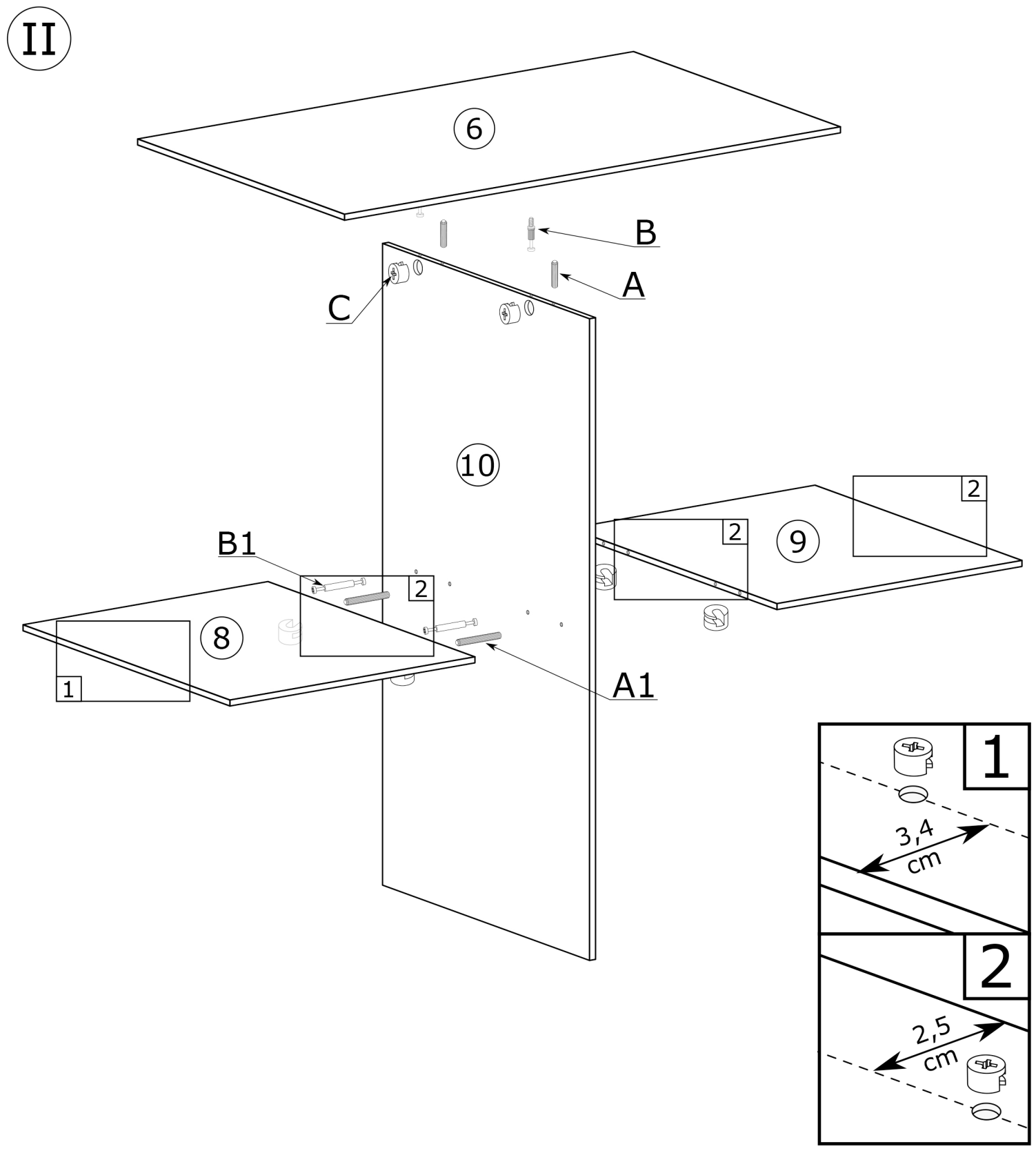
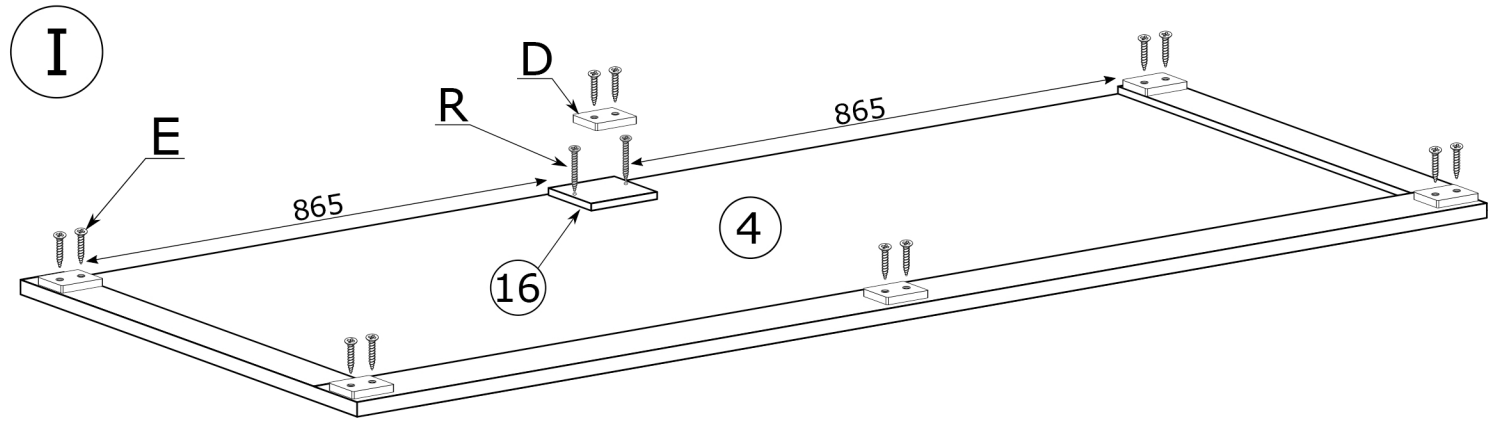

III

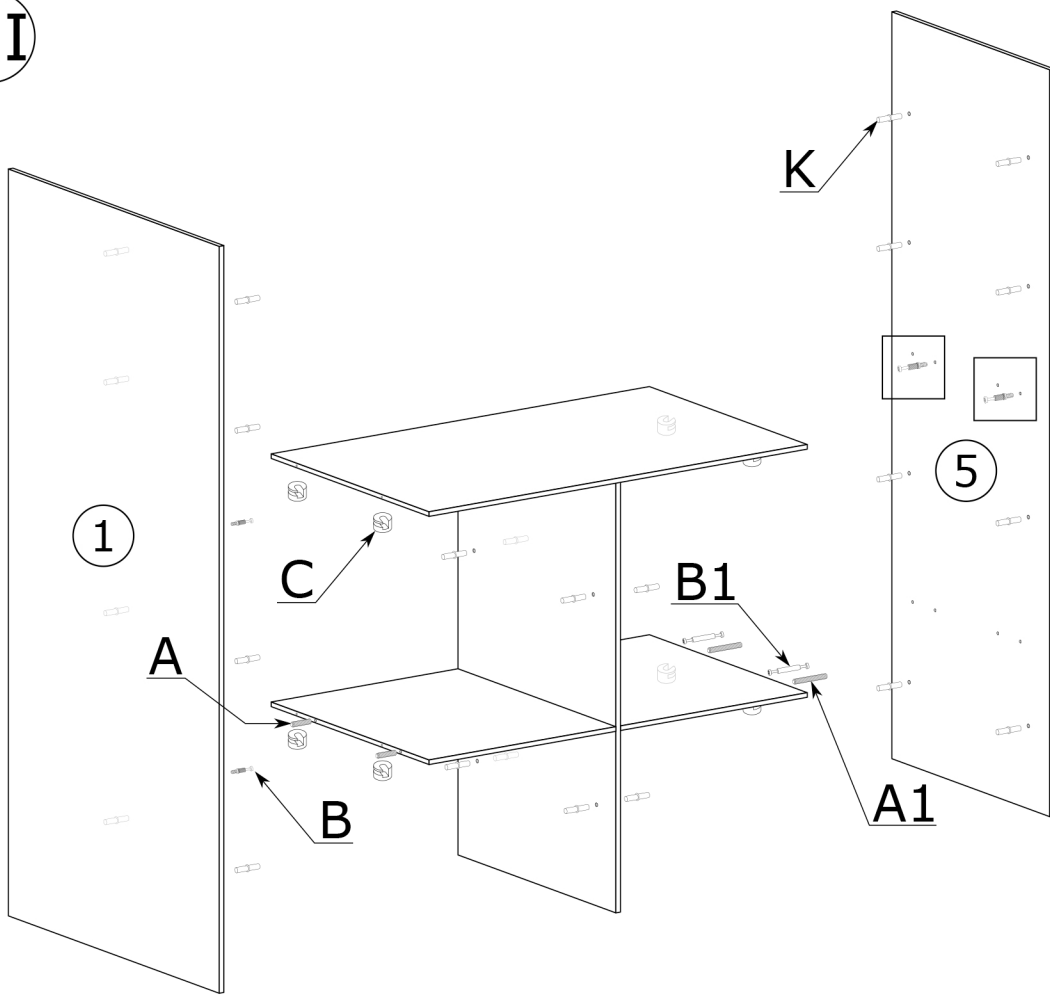

IV

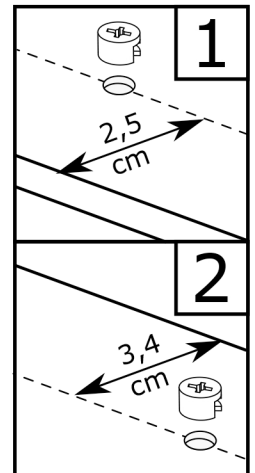
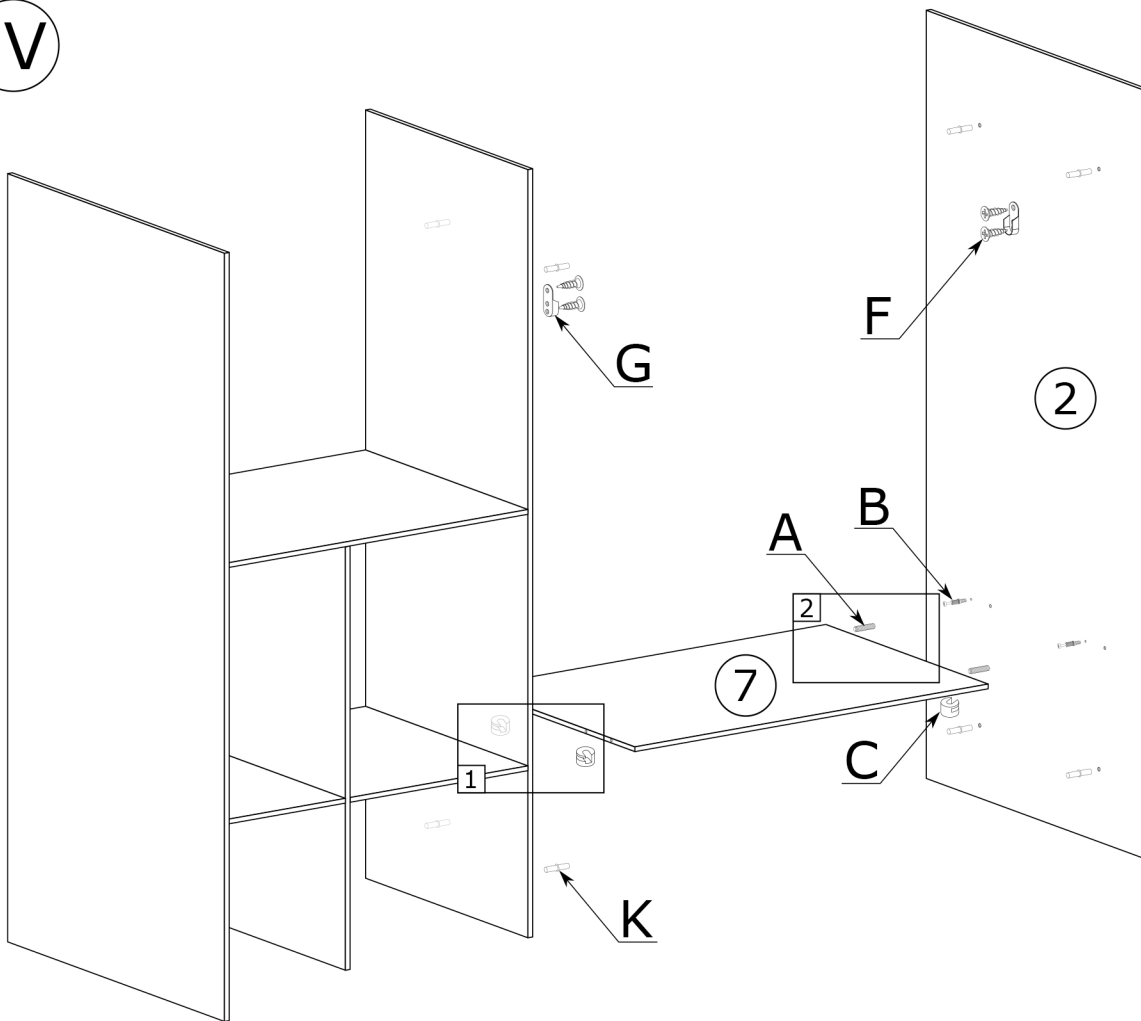

V

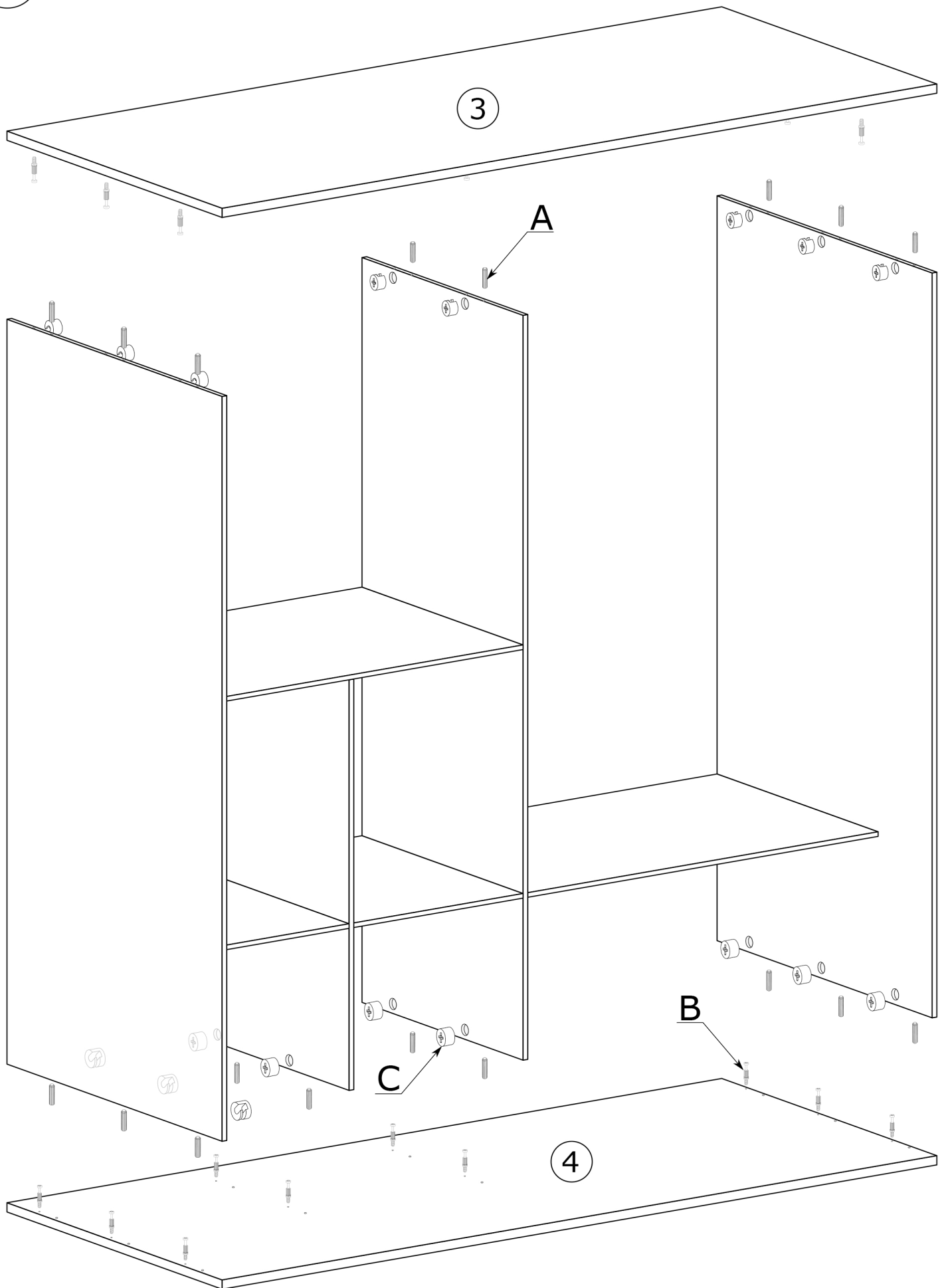

VI

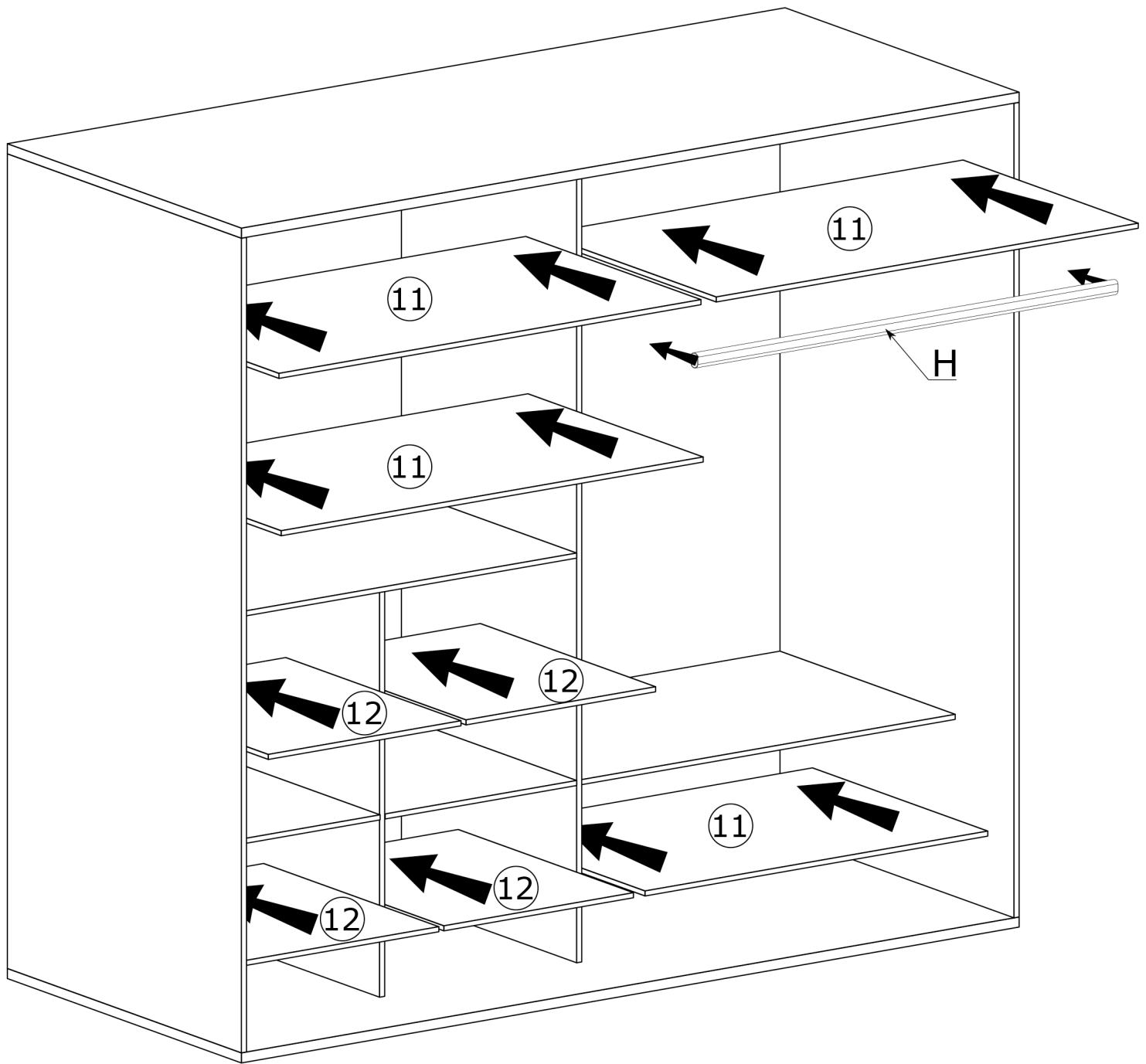

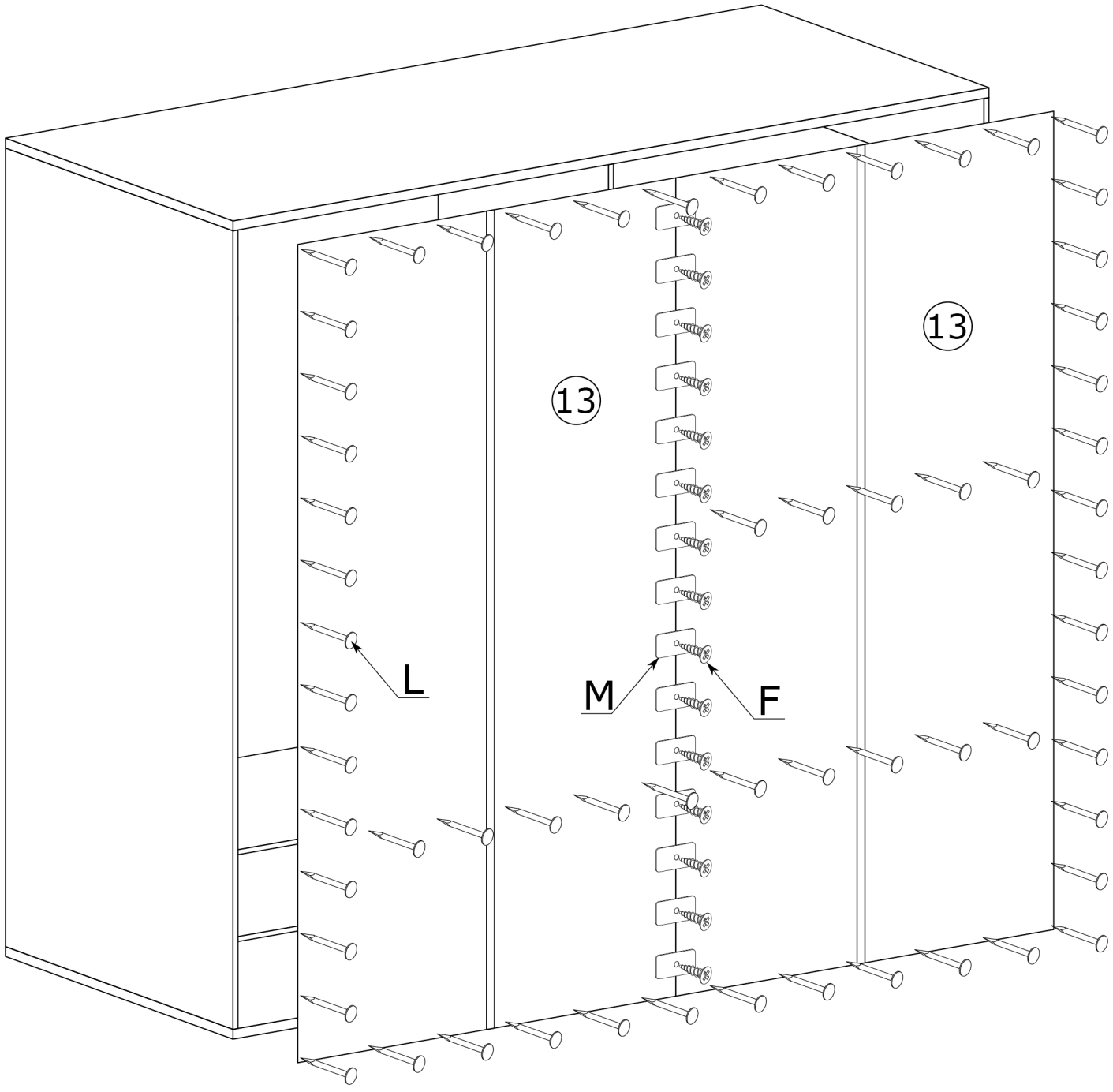

x120

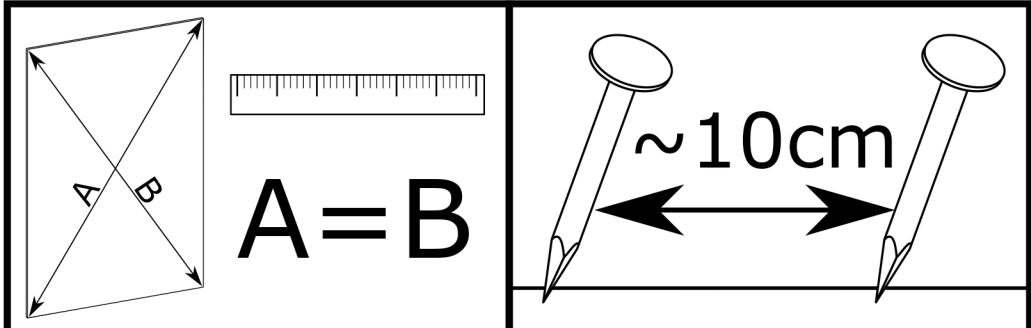
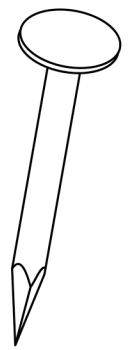

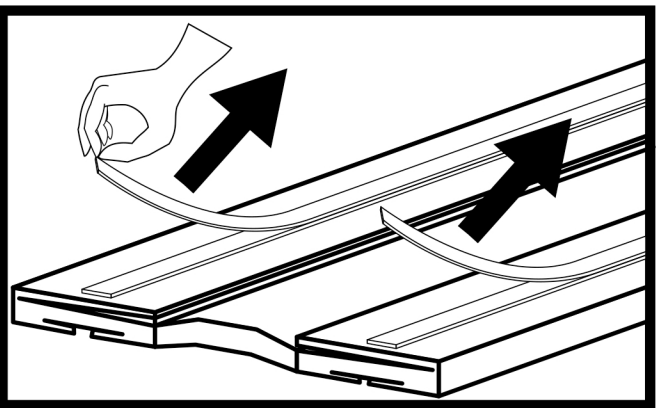
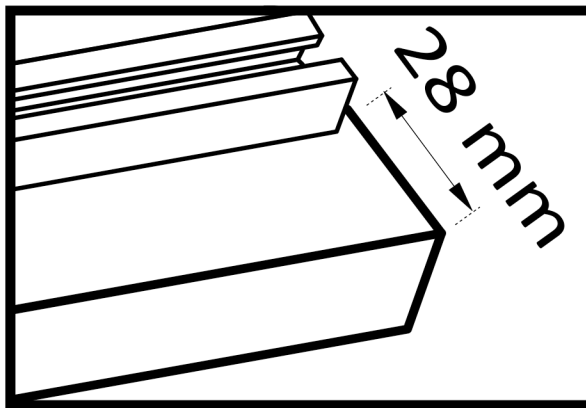
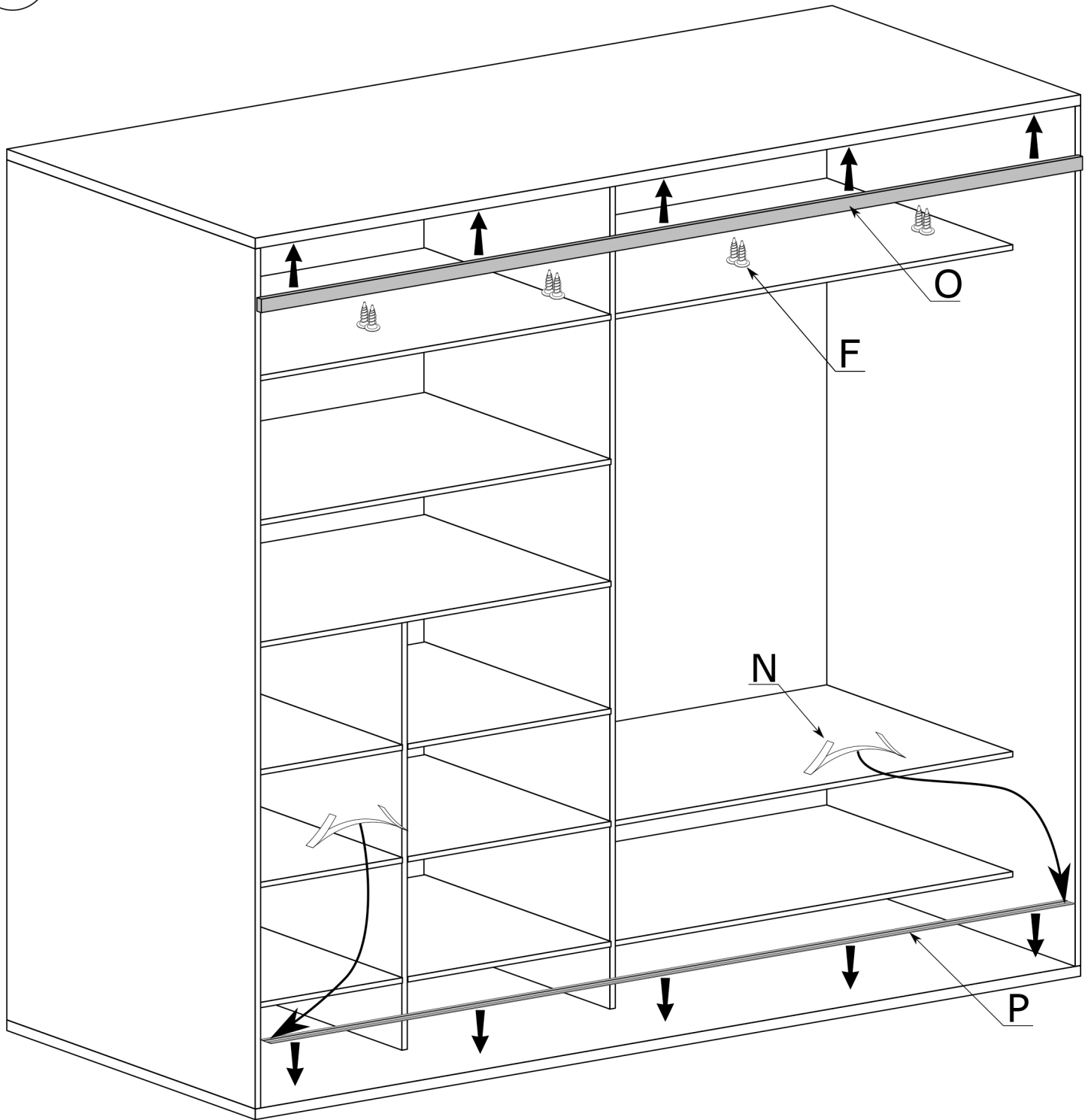

IX

F

I

15

14

J

S

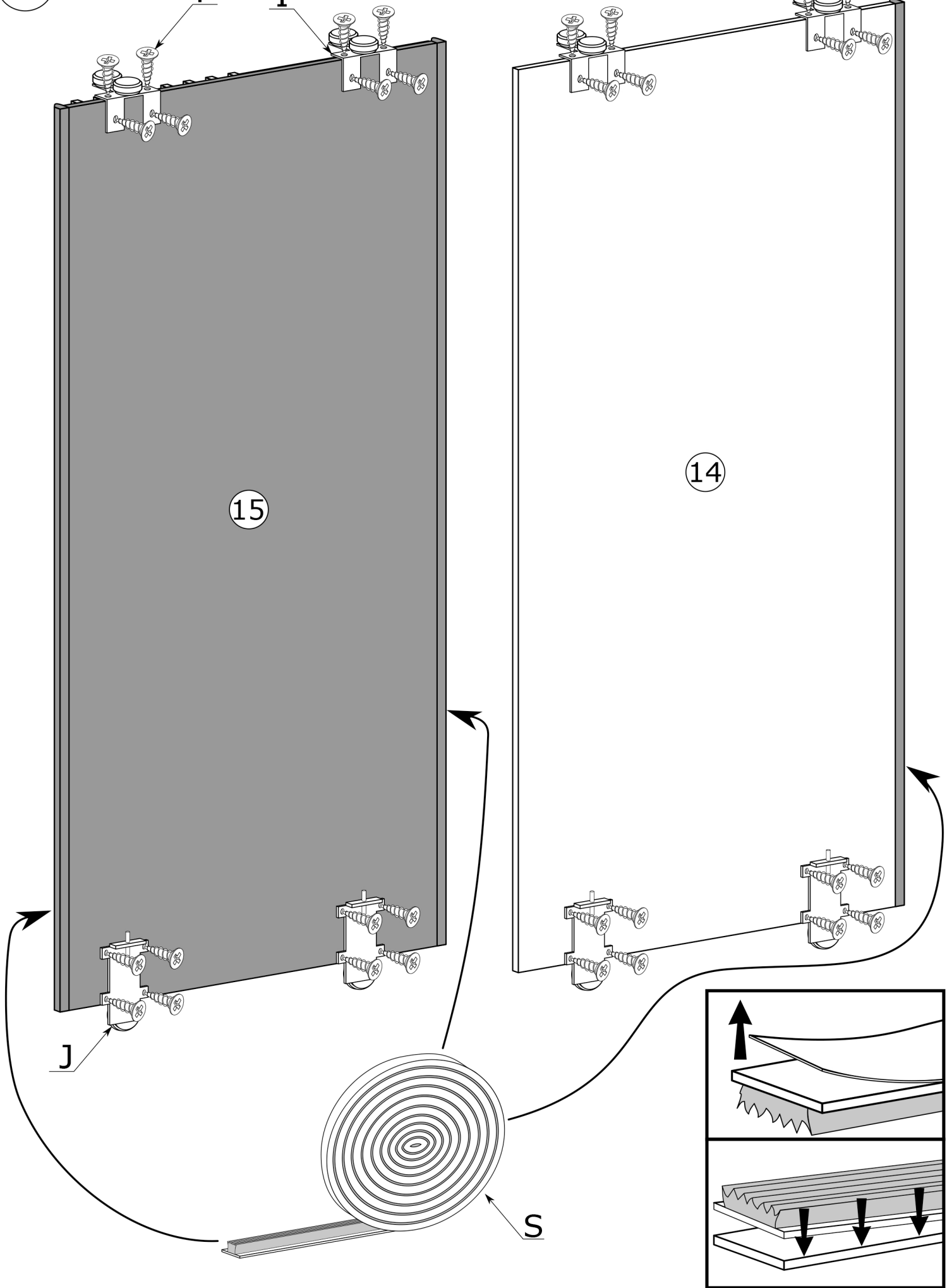

X

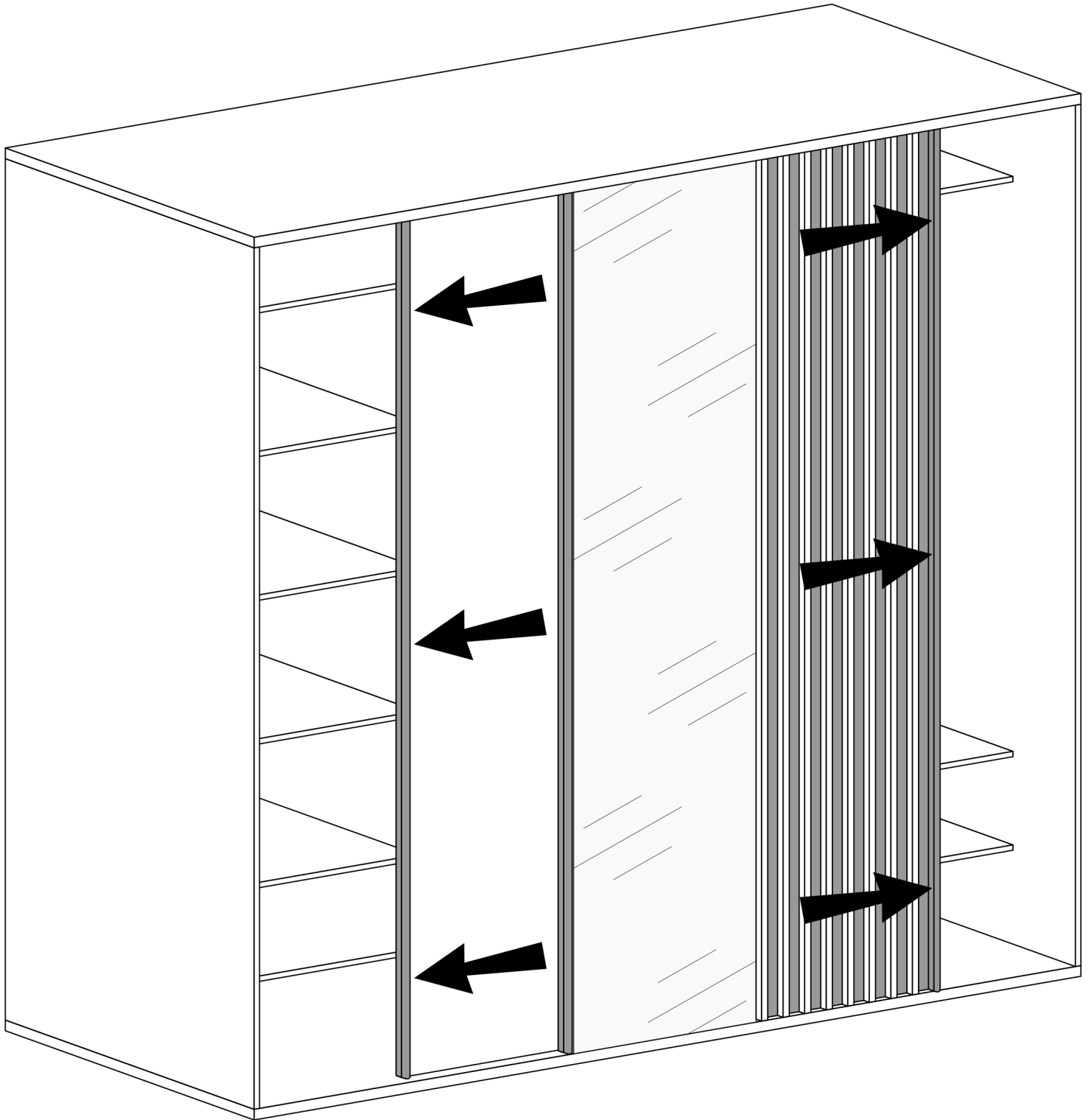

A

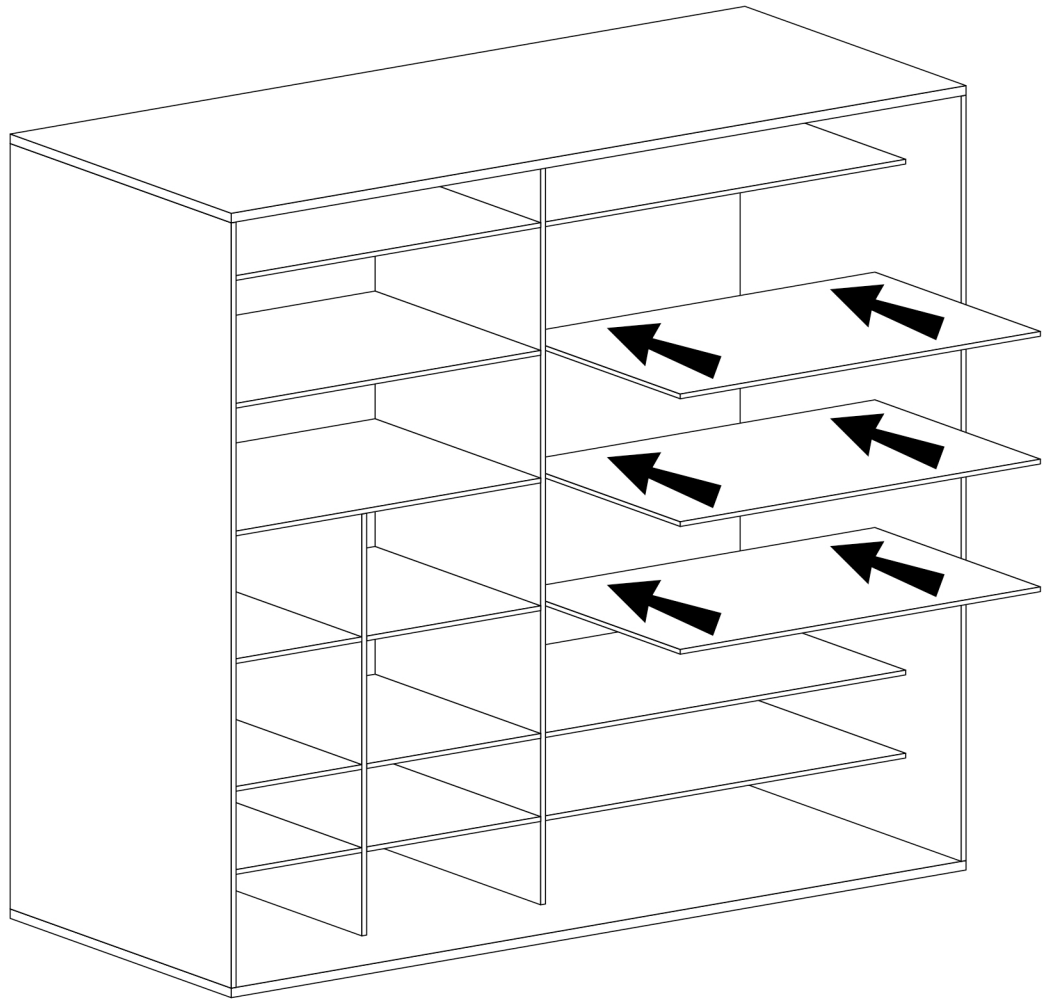
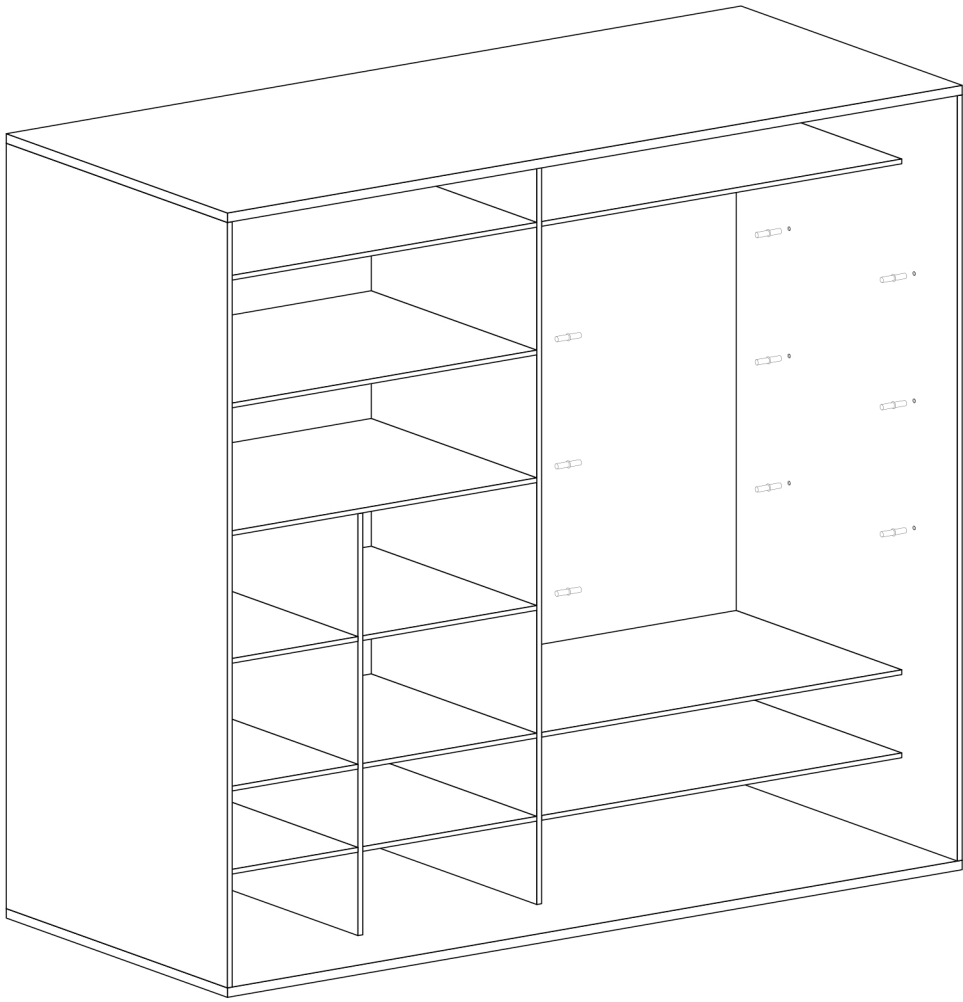

1

2

3

4

